



| Typical Features | |
|------------------|--|
| ◆ | Fixed input voltage, isolated & regulated, output power 1.0W |
| ◆ | Efficiency up to 73% (Typ.) |
| ◆ | Mini SMD package, international standard pin-out |
| ◆ | Isolation Voltage 3000VDC |
| ◆ | Operating Temperature from -40°C to +85°C |
| ◆ | Plastic case, flame class UL94 V-0 |

Test conditions: Unless otherwise specified, all parameter values had been tested at rated input voltage, pure resistive rated load, and at room temperature 25 °C.

Application Filed

This series of converters can be widely used in the fields of instrument, communication, pure digital circuit, general low frequency analog circuit, relay drive circuit, data exchange circuit, etc.

Typical Product List

| Certificate | Part No. | Input Voltage Range (VDC) | | Output Voltage/Current | | Input Current (mA)Typ. @Rated Voltage | | Max. Capacitive Load | Ripple & Noise 20MHz (mVp-p) | Efficiency (%) @full load/rated input | |
|-------------|-----------------|---------------------------|---------------|------------------------|-------------------|---------------------------------------|---------|----------------------|------------------------------|---------------------------------------|-----|
| | | Rated | Range | Vo (VDC) | Io (mA) Max / Min | Full load | No Load | uF (Max) | Max/Typ | Min | Typ |
| - | NW1-3V3S3V3A3NT | 3.3 | 3.135 - 3.465 | 3.3 | 250/20 | 290 | 8 | 2400 | 80/50 | 67 | 70 |
| RoHS | NW1-05S3V3A3NT | 5 | 4.75 | 3.3 | 250/25 | 290 | 6 | 2400 | 80/50 | 67 | 70 |
| RoHS | NW1-05S05A3NT | | - | 5 | 200/20 | 265 | 6 | 2400 | 80/50 | 70 | 73 |
| RoHS | NW1-05S12A3NT | | 5.25 | 12 | 84/9 | 260 | 8 | 560 | 80/50 | 70 | 73 |
| - | NW1-12S3V3A3NT | 12 | 11.4 | 3.3 | 250/25 | 110 | 8 | 2400 | 80/50 | 67 | 70 |
| - | NW1-12S05A3NT | | - | 5 | 200/20 | 108 | 8 | 2400 | 80/50 | 70 | 73 |
| - | NW1-12S12A3NT | | 12.6 | 12 | 84/9 | 107 | 8 | 560 | 80/50 | 70 | 73 |
| - | NW1-24S3V3A3NT | 24 | 22.8 | 3.3 | 250/25 | 56 | 8 | 2400 | 80/50 | 67 | 70 |
| - | NW1-24S05A3NT | | - | 5 | 200/20 | 54 | 8 | 2400 | 80/50 | 70 | 73 |
| - | NW1-24S12A3NT | | 25.2 | 12 | 84/9 | 52 | 8 | 560 | 80/50 | 70 | 73 |

Note - The ripple and noise are tested by the twisted pair method.

Input Specifications

| Item | Operating Condition | Min. | Typ. | Max. | Unit |
|-------------------------------------|---------------------|------|------|------|------|
| Input inrush voltage (1Second Max.) | 3.3Vdc Input | -0.7 | -- | 7 | Vdc |
| | 5Vdc Input | -0.7 | -- | 9 | |
| | 9Vdc Input | -0.7 | -- | 12 | |
| | 12Vdc Input | -0.7 | -- | 18 | |

| | | | | | |
|-------------------|------------------|------|----|----|--|
| | 15Vdc Input | -0.7 | -- | 21 | |
| | 24Vdc Input | -0.7 | -- | 30 | |
| Input Filter Type | Capacitor Filter | | | | |
| Hot Plug | Unavailable | | | | |

Output Specifications

| Item | Operating Condition | Min. | Typ. | Max. | Unit |
|-------------------------------|--------------------------------|------|------|-------|------|
| Output Power | | 0.1 | -- | 1.0 | W |
| Output Voltage Accuracy | Rated input voltage, full load | -- | ±2 | ±3 | % |
| Load Regulation | 10%-100% load | -- | -- | ±3 | |
| Line Regulation | Input voltage change ±1% | -- | -- | ±0.25 | |
| Temperature Drift Coefficient | Full load | -- | -- | ±0.03 | %/°C |
| Short Circuit Protection | Continuous, Self-recovery | | | | |

General Specifications

| Item | Operating Condition | Min. | Typ. | Max. | Unit |
|---------------------------|---|-------------------------------------|------|------|---------|
| Switching Frequency | Rated input voltage, full load | -- | 260 | -- | KHz |
| Operating Temperature | Refer to the temperature derating curve | -40 | -- | +85 | °C |
| Storage Temperature | | -55 | -- | +125 | |
| Case Temperature Rise | Operating at Ta =25°C | -- | 30° | -- | |
| Pin Soldering Temperature | 1.5mm from the case, 10S | -- | -- | 300 | |
| Reflow Temperature | Peak temperature Tc ≤250°C, the maximum time above 217°C is 60S | | | | |
| Relative Humidity | No condensing | 5 | -- | 95 | %RH |
| Isolation Voltage | Input-Output, test 1min, leakage current <1mA | 3000 | -- | -- | VDC |
| Insulation Resistance | Input-Output, @ 500Vdc | 1000 | -- | -- | MΩ |
| Isolation Capacitor | Input/Output, 100KHz/0.1V | -- | 20 | -- | pF |
| MTBF | MIL-HDBK-217F@25°C | 3500 | -- | -- | K hours |
| Vibration | | 10-150Hz, 10G, 30Min, along X, Y, Z | | | |
| Case Material | Plastic in Black, flame class UL94 V-0 | | | | |
| Product Weight | 1.4 g (Typ.) | | | | |
| Cooling Method | Natural air | | | | |

EMC Performance

| | | | | | |
|-----|-----|---|--|--|--|
| EMI | CE | CISPR32/EN55032 CLASS B (with Recommended EMC Circuit) | | | |
| | RE | CISPR32/EN55032 CLASS B (with Recommended EMC Circuit) | | | |
| EMS | ESD | IEC/EN61000-4-2 Air ±8kV, Contact ±4kV perf. Criteria B | | | |

Mechanical Dimensions

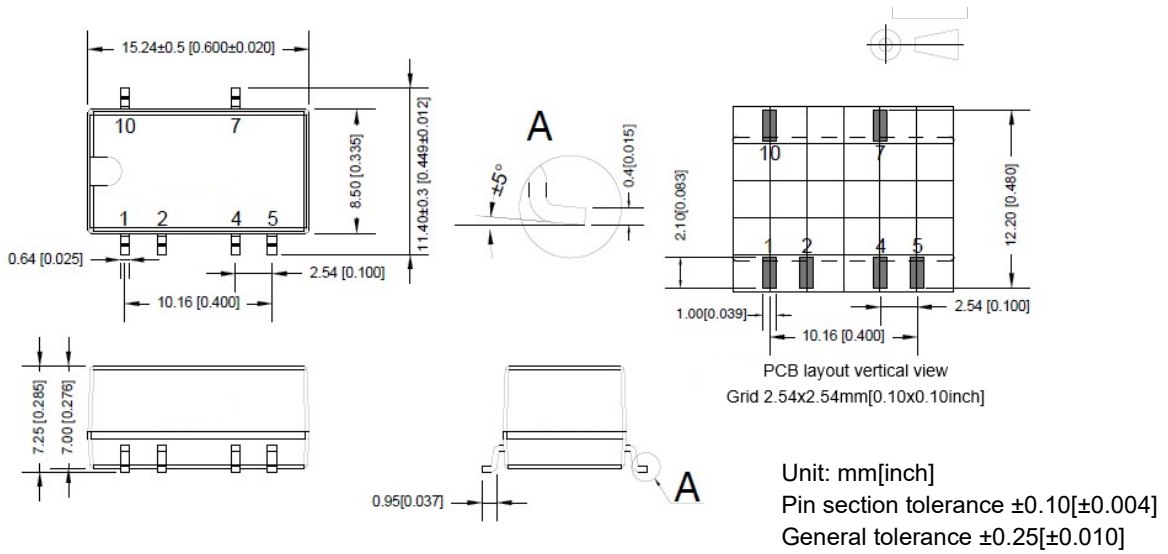

| | | |
|----------------|----------------------|------------------------|
| Packaging Code | Dimensions L x W x H | |
| A3NT | 15.24x11.40x7.25 mm | 0.600x0.449x0.285 inch |

Pin-out Definition

| | | | | | | |
|----------------|-----------|----------|-----------|-----------|-----------|---------------|
| Pin No. | 1 | 2 | 4 | 5 | 7 | 10 |
| Pin definition | GND | +Vin | -Vo | -Vo | +Vo | NC |
| Description | Input GND | Input V+ | Output V- | Output V- | Output V+ | No connection |

Note - Please take the pin definition on the product label marking as the right one if it is different than the one defined in this data sheet.
Pin #10 NC should not connect to any circuit.

Ripple & Noise Test Instructions (Twisted Pair Method, 20MHz Bandwidth)

- The Ripple & noise test need 12# twisted pair cables, an oscilloscope which bandwidth should be set to 20MHz, 0.1uF polypropylene capacitor and 10uF high-frequency low-resistance electrolytic capacitor are connected in parallel with the probes (100M bandwidth). The oscilloscope should be set at the Sample Mode.
- The test diagram is shown on the right. The converter output connects to the electronic load by the jig with cables which size should be defined according to the output current value. The twisted pair (length 30cm \pm 2 cm) should be connected in parallel with the load, the location is as close as possible to the output pins or terminals. The test can be started after input power on.

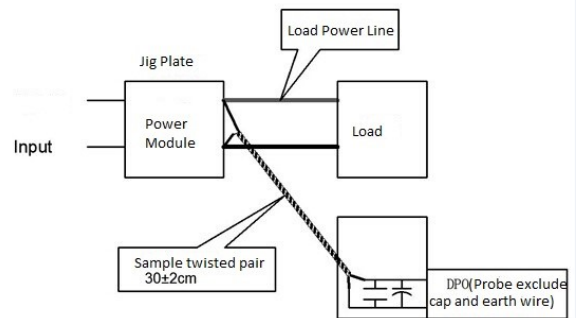

Product Performance Curve

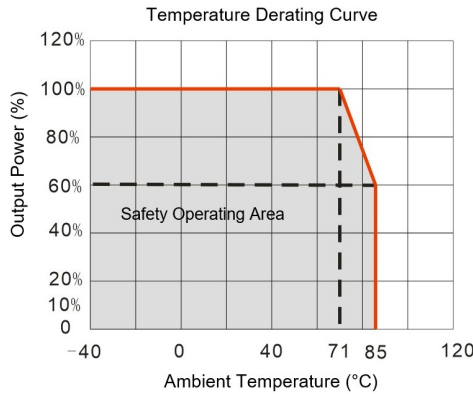

Recommended Circuits for Application

① **Output load requirement**

The maximum capacitive load of the product was tested at the Rated full load. The converter may not start or be damaged if the output capacitor exceeds this value.

② **Recommended circuits for application**

To effectively decrease the input and output ripple and noise, a capacitor filter should be connected at the input and output, the application circuit is shown in the figure below. The suitable filter capacitors should be chosen as the recommended capacitive load values in Table 1. The converter could not start if the capacitance is too big.

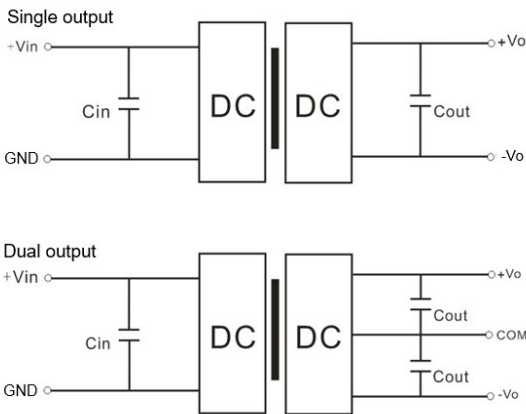

Recommended Capacitive Load Value Table (Table 1)

| Vin (Vdc) | Cin | Single Vout (Vdc) | Cout (μF) | Dual Vout (Vdc) | Cout (μF) |
|-----------|------------|-------------------|------------|-----------------|-------------|
| 5 | 10 μF/16V | 3.3 | 10 μF/16V | ±3.3 | 4.7 μF/16V |
| 12 | 2.2 μF/25V | 5 | 10 μF/16V | ±5 | 4.7 μF/16V |
| 15 | 2.2 μF/25V | 9 | 2.2 μF/25V | ±9 | 2.2 μF/25V |
| 24 | 1 μF/50V | 12 | 2.2 μF/25V | ±12 | 1 μF/25V |
| -- | -- | 15 | 1 μF/25V | ±15 | 1 μF/16V |
| -- | -- | 24 | 1 μF/50V | ±24 | 0.47 μF/50V |

③ **Recommended EMC Circuit**

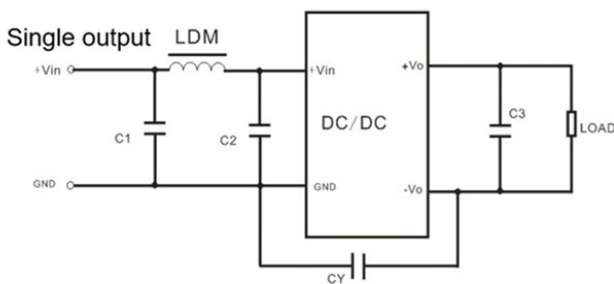

| Input voltage | | 5VDC | 12/15/24VDC |
|---------------|-------|--------------------------|-------------|
| EMI | C1/C2 | 4.7 μF/16V | 4.7 μF/50V |
| | CY | 270pF/4KV | 270pF/4KV |
| | C3 | Refer to Cout in Table 1 | |
| | LDM | 6.8 μH | 6.8 μH |

Packing information

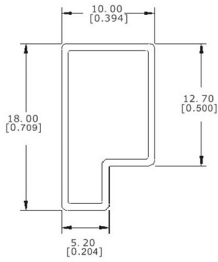

Note:
Unit: mm[inch]
General tolerance: ±1.50[±0.059]
Packing QTY: 33pcs/Tube
Packing QTY: 2640pcs/Carton
Tube size: 525x18x10mm
Carton size: 542x110x155mm

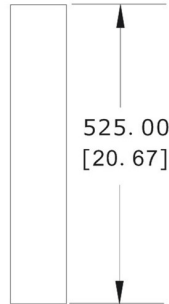

Tube packing

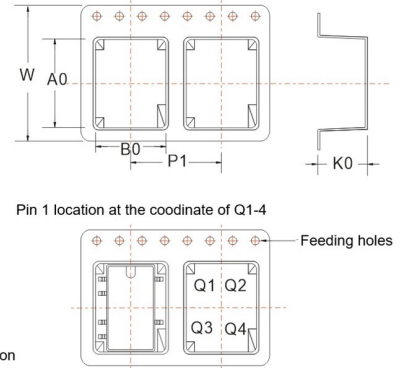
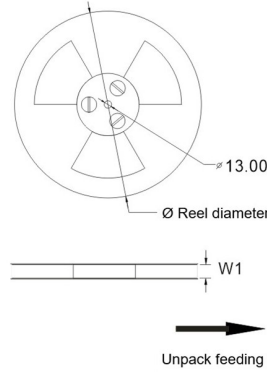

| Part No. | Packaging Type | Pin | SPQ | Reel Diameter (mm) | Reel Width W1 (mm) | A0 (mm) | B0 (mm) | K0 (mm) | P1 (mm) | W1 (mm) | Pin1 Location |
|-----------------|----------------|-----|-----|--------------------|--------------------|---------|---------|---------|---------|---------|---------------|
| NWX-XXSXXA(3)NT | SMD | 6 | 500 | 330.0 | 24.5 | 15.65 | 12.05 | 8.0 | 16.0 | 24.0 | Q1 |

Reel packing (500pcs per Reel)

Application Notice

- 1.This product cannot be used in parallel, and it does not support hot-plugging.
- 2.The product performance in this manual cannot be guaranteed if it works at a lower load than the minimum load condition.
3. All values or indicators in this manual had been tested based on Aipupower test specifications.

Guangzhou Aipu Electron Technology Co., Ltd

Address: Building 4, HEDY Park, No.63, Punan Road, Huangpu Dist, Guangzhou, China.

Tel: 86-20-84206763 Fax: 86-20-84206762 HOTLINE: 400-889-8821

E-mail: sales@aipu-elec.com Website: <https://www.aipupower.com>